

model series: HY-4-7 and HY-6-7

**Super Bright LEDs: RED, GREEN, YELLOW or BLUE - 7 INCH High Digits
4 and 6 DIGITS**

Metal and Stainless Steel Enclosures
Black, White, Chrome and Gold colors

STANDARD FEATURES:

- * Infra Red hand held REMOTE CONTROL for all functions
- * 12 or 24 Hour and Military Display Format (user selectable via remote)
- * Stand - Alone operation for Home or Office
- * Backup:
Self-recharging backup - NO BATTERY NEEDED
- * Day/Date/Month/Year Alternating display selection
- * Fully Adjustable Brightness (Manual via remote control)
- * Julian Day display
- * Auto Leap-Year correction
- * Day Light Savings correction (N. America)
- * Timers:
Wake-Up Alarm Timer with soft beeper control
Stop-Watch function up to 1/100 sec resolution
Up/Down Presettable Timer and Counter with Alarm (up to 99hrs:59min:59sec or 999999 counts)
Cycling timer, Up and Down
- * On-Board Alarms: Internal Alarm buzzer
- * NON-GLARE lens
- * NON-MULTIPLEXING - Camera friendly
- * Variety of enclosure colors.



IR Remote Control

SPECIFICATIONS:

Supply Voltage:	115V or 208-240V, 50/60Hz 24 or 12V AC/DC
Power:	12VA average
Operating Temperature:	0C to +50C (32F to 122F) (military range optional)
Humidity:	95% RH max. non cond.
4-digits model Dimensions:	24.5" x 10" x 3" (62.3cm x 25.4 x 7.6cm)
6-digits model Dimensions:	35.25" x 10" x 3" (89.5cm x 25.4cm x 7.6cm)
Visibility:	Up to 250 Ft. (80m)

Optional FEATURES:

- * Direct Replacement for existing MASTER - SLAVE SYSTEM CLOCKS (replaces round, mechanical or electronic)
- * Multiple Master-Slave correction modes:
Master-Slave Power Line Carrier sync (Simplex)
Master-Slave 2 Wire, RS485 Twisted Pair Sync/Communication
Master-Slave wireless communication on power line wiring
Master-Slave wireless RF, radio communication
Master-Slave network ethernet communication
Master-Slave BCD digital, ASCII Time Code
RS232, USB and RS485 serial communication (PC port as the Master)
Master-Slave 2 and 3 Wire, 24V Minute Impulse Sync
- * Multi-Zone synchronized Master-Slave system
- * Temperature Monitoring and Control:
Multi-Event Programmable Thermostat (up to 32 events/day)
Heating - Cooling Auto Change-Over
Inside and Outside Thermometer function
Min/Max Temperature Memory
Temperature Alarm and Relay outputs (up to 2 x Form C, 10Amp/250V)
- * Backup:
10 Year Lithium battery option
- * Atomic Clock radio option
(WWVB60, DCF77, HBG75, MSF60, OHTAKADOYA40, HAGANE60)
- * Atomic Clock GPS option
- * Automatic Brightness with Auto-dimming option
- * Timers:
Multi-Event Programmable Timer (up to 32 events/day)
Stop-Watch function up to 1/100 sec resolution
External Start/Stop/Reset switch inputs
Auto-reloading time period measurement
Continuous time count on power failure
- * On-Board Alarm Relays for timers and counters:
(up to 2 x Form C, 10Amp/250V) For external load, siren or horn.



standard color: black
custom colors: chrome, gold , stainless steel and other

4-digit model

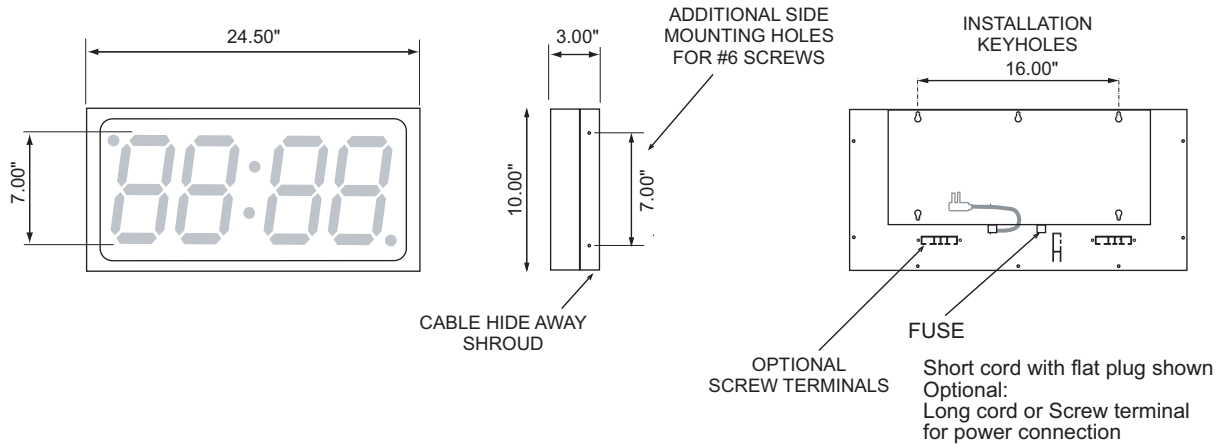

6-digit model

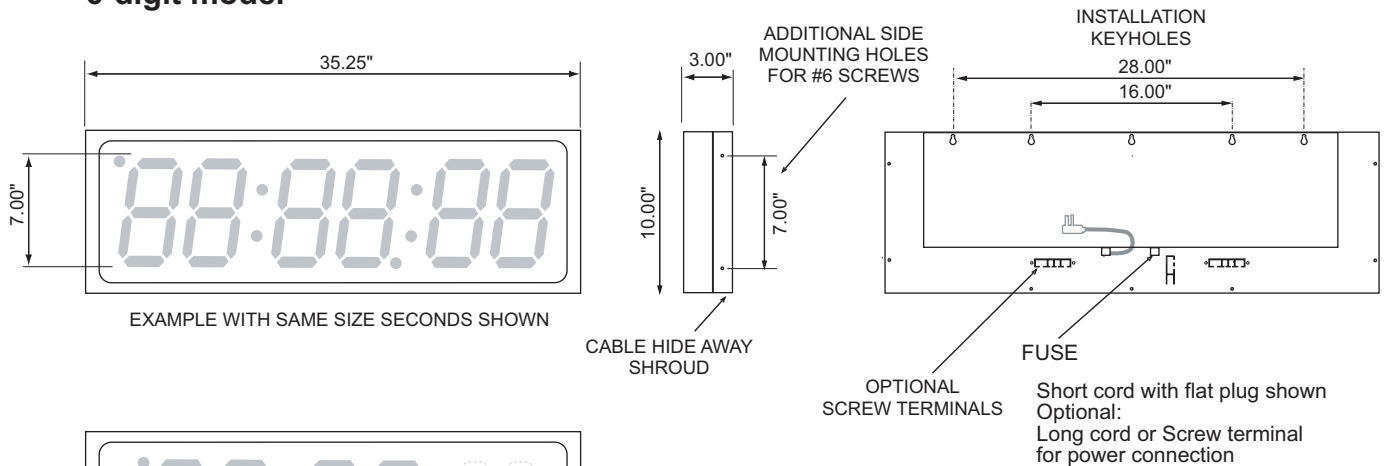

OPTIONAL DOUBLE-SIDED MOUNTING BRACKET (OPTION # BR7X2)

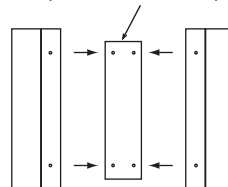

standard color: black
custom colors: chrome, gold , stainless steel and other

OPTIONAL FLUSH MOUNT METHODS

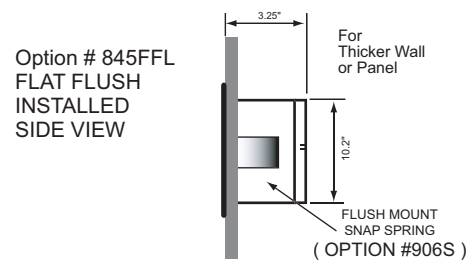
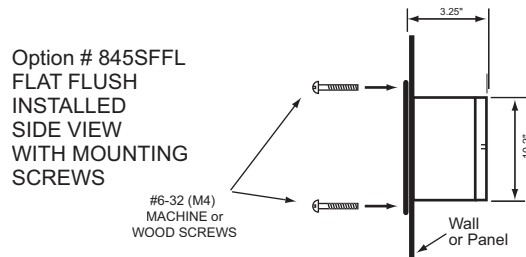

4 DIGITS MODEL

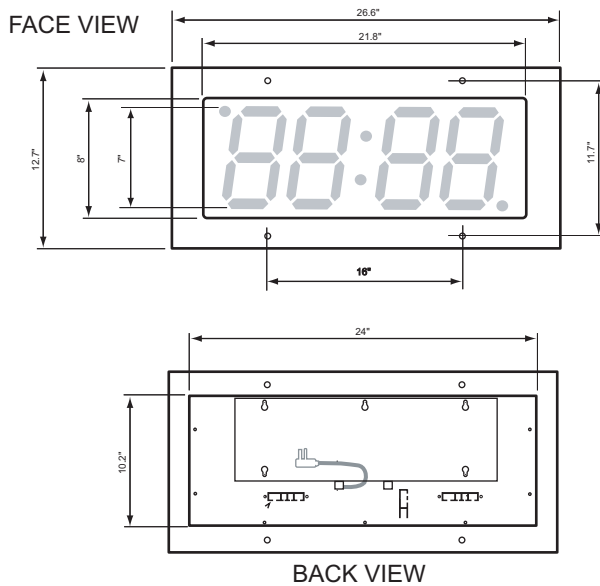

6 DIGITS MODEL

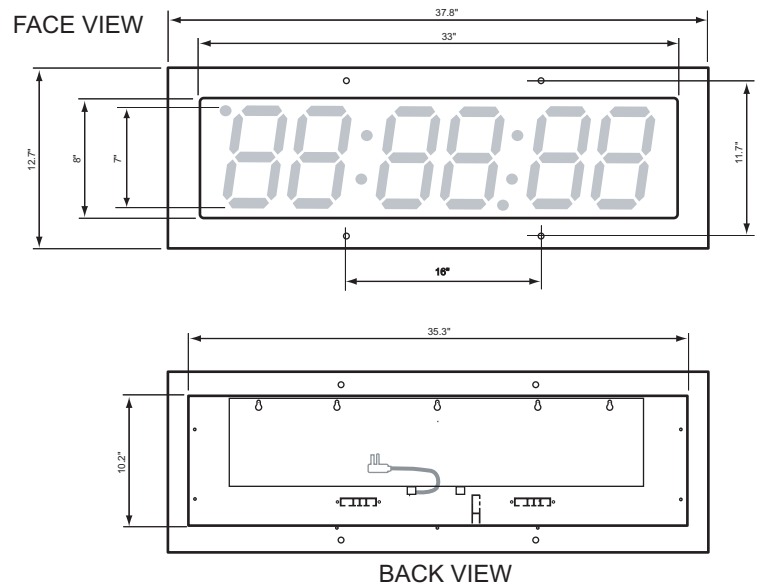

BACK PANEL SIDE VIEW

ENCLOSURE
BACK PANEL
series 732R or 732

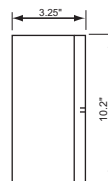

Straight 90 Deg. Back flange
(also used for back-to-back mounting)

